

**Analog/digital watch –
Multi frequency reception, 4 digit LCD, 3 hands**

Preliminary Specification

Supplier: C-MAX Asia Limited Unit 125, 1/F., Liven House, 61-63 King Yip Street, Kwun Tong, HK SAR

Issued on: **20.12.2005**

Issued by: C-MAX Asia Limited Unit 125, 1/F., Liven House, 61-63 King Yip Street, Kwun Tong, HK SAR

1.0 Functional Overview

Feature	Analog module with electronic adjust
Motor	Single second motor
Local Time display	Hour:minute or second or date:day of week or time zone shown on LCD. Hands show second, minute and hour information.
Date	Can be shown on LCD together with day of the week
Day of the week	Can be shown on LCD together with date
Manual time setting	Via electronic adjust seen on LCD
Time Zone display	Up to 24 different time zones can be manually adjusted. Time zone can be also shown on LCD
Bond Option	Set default time zone upon power on; Set global (triple band) or local (dual or single) signal reception
DST detection	DST detection and update is default automatic for reception areas. For no radio control reception areas, DST is turned off by default. Can manually force DST on or off. Once DST active, icon will appear on LCD
Radio controlled signal reception	Auto reception maximum 3 times daily. Manual reception will only be performed if user manually activates RCC reception by button pressed. Signal to be received depends on time zone set
During reception	Hands will move normally during auto and manual reception Hands will not move during reception after zero calibration
Reception result indicator	Single button pressed show result on LCD display.
Low bat indication	If low batt detected, low bat icon will be displayed on LCD.
Back light	No back light
Multi-frequency reception	Only when time zone is set to Japan and Europe JPN : JJY40 → JJY60 UK: MSF → DCF EU: DCF → MSF Sequence depends on previous reception result hereafter

2.0 LCD Display

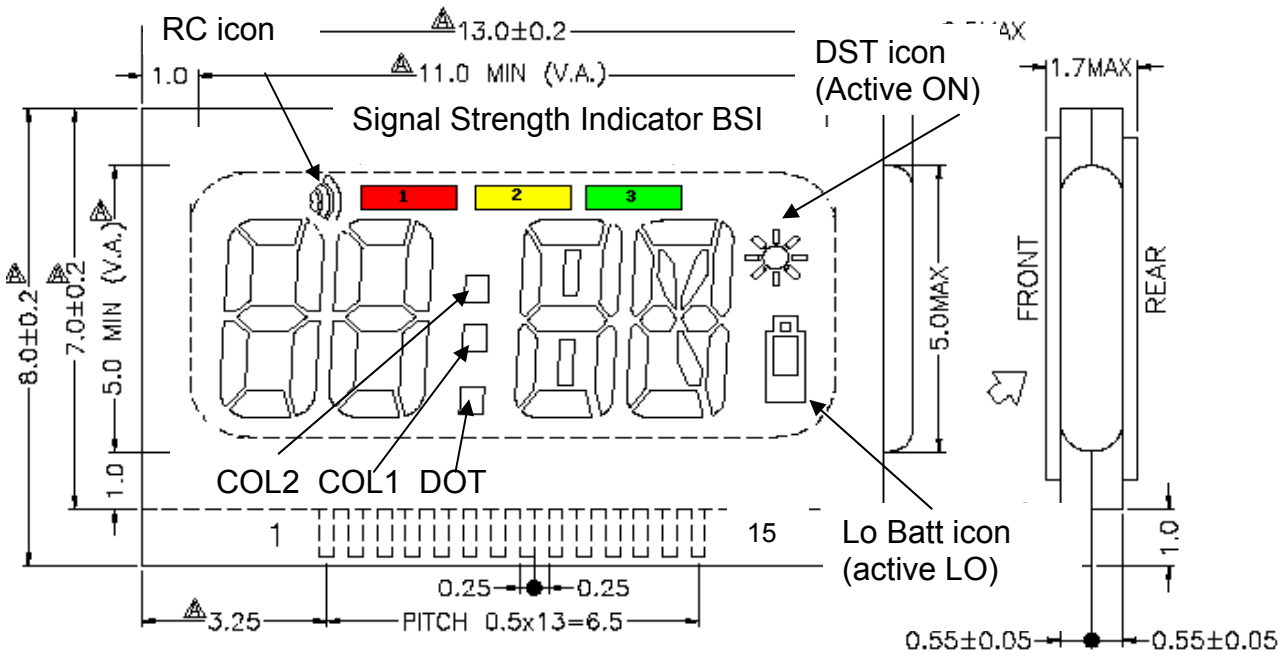

PIN	1	2	3	4	5	6	7	8	9	10	11	12	13	14	15
SEG					S11	S1	S2	S3	S4	S5	S6	S7	S8	S9	S10
COM0	COM0				BS3	1A	BATT	2A	RC	--	3A	3H	DST	4A	4B
COM1		COM1			BS2	1F	1B	2F	2B	COL2	3F	3B	4F	4I	4J
COM2			COM2		BS1	1E	1G	2E	2G	COL1	3E	3G	4E	4G	4K
COM3				COM3	--	1D	1C	2D	2C	DOT	3D	3C	4D	4L	4C

3.0 Button definition

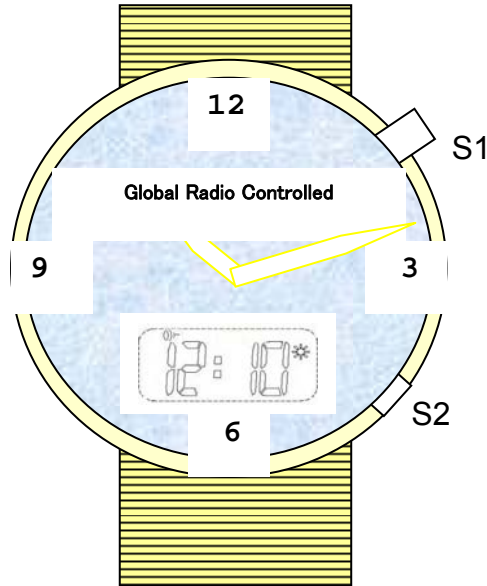

4.0 Modes Overview

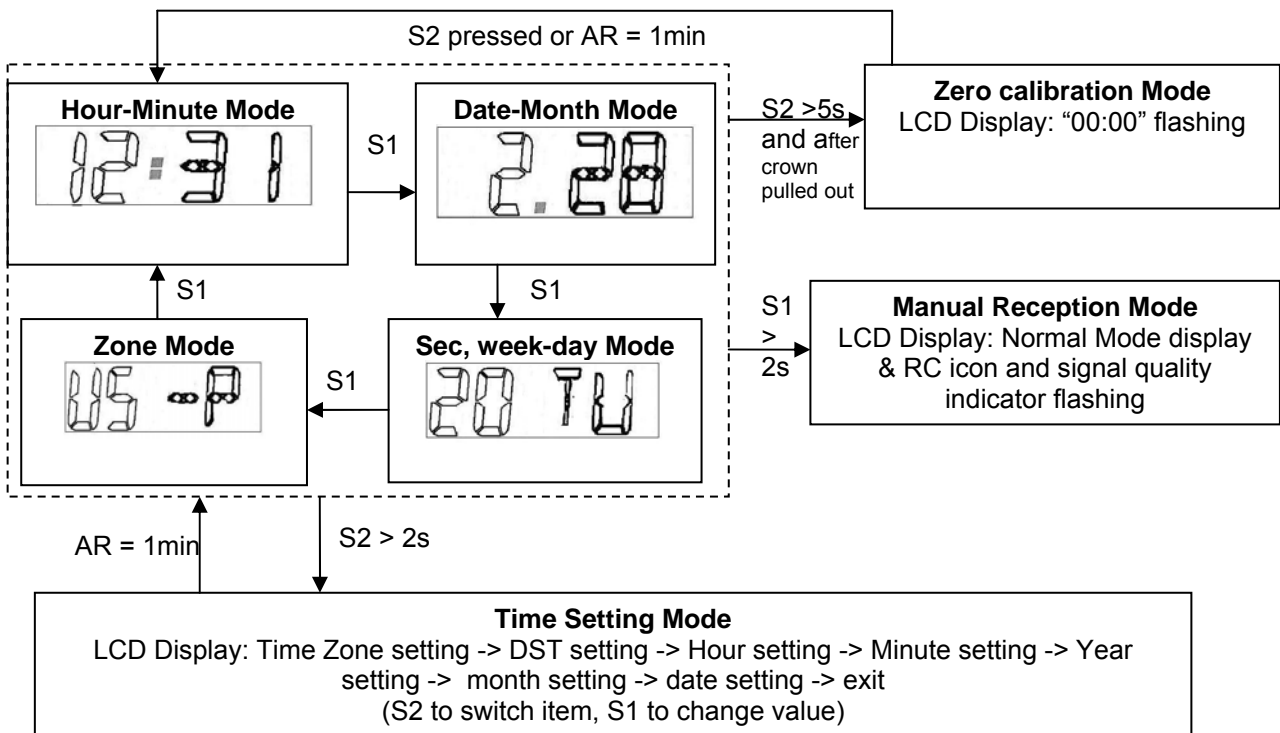

4.1 After reset / battery power on

After hardware reset or battery power on, the user must set the hands to 0-position by operation as follows:

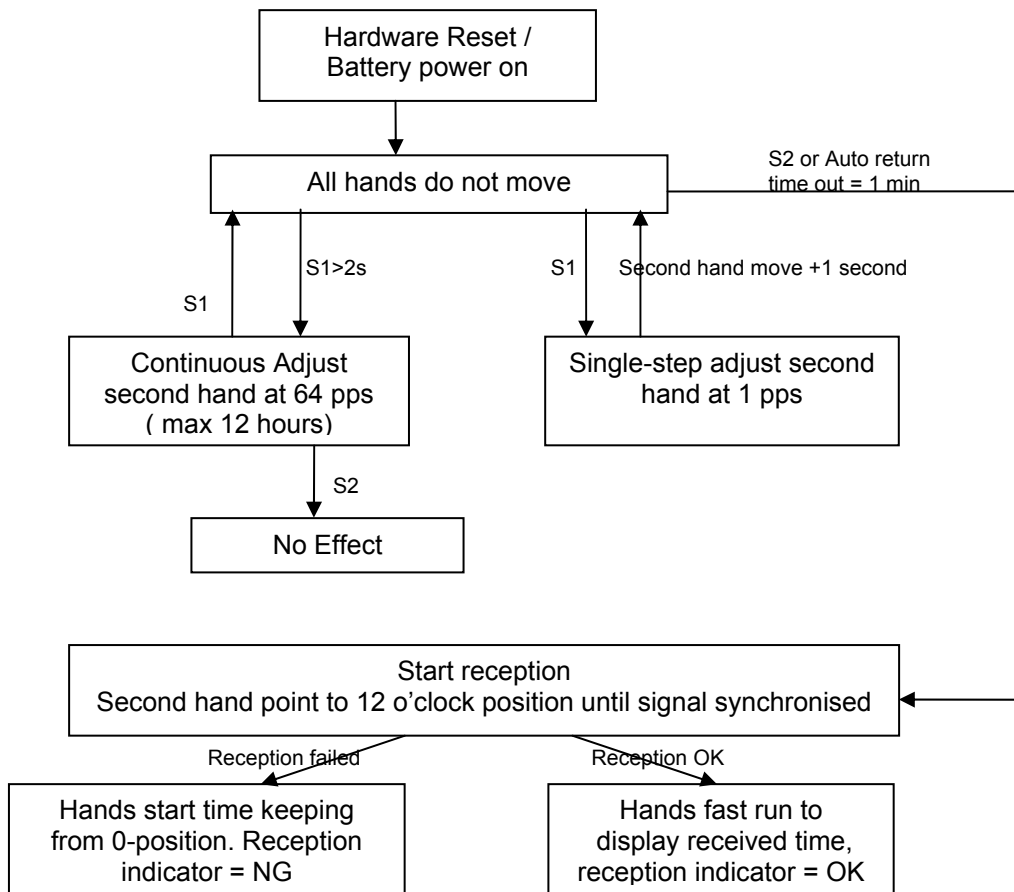

Automatically a receiving mode is started after the calibration mode is quitted after manually by pressing S1 or by auto-return time out (= 1 minute). After zero calibration, reception will synchronize minutes, seconds, and hours. If no S2 was pressed after continuous fast adjust has started for 12 hours, the needles will stop by itself, and after 1 minute watch will start reception automatically.

Bond Option for default time zone

P11	P10	Default time zone	Reception signal
L	L	UTC + 9H (Japan)	JJY40 -> JJY60
L	H	UTC - 5H (USA-E)	WWVB
H	L	UTC + 0H (UK)	MSF -> DCF
H	H	UTC + 1H (EU)	DCF -> MSF

Note:
For Japan, USA time bond option : show month-date format
For other bond option : show date-month format

4.2 0-calibration

The calibration mode can be started by pressing the S2 button longer than 5 seconds. In 0 calibration, there are two different modes of adjustment: second hand fast adjust at 64 pps and minute adjust. Operation is as follows:

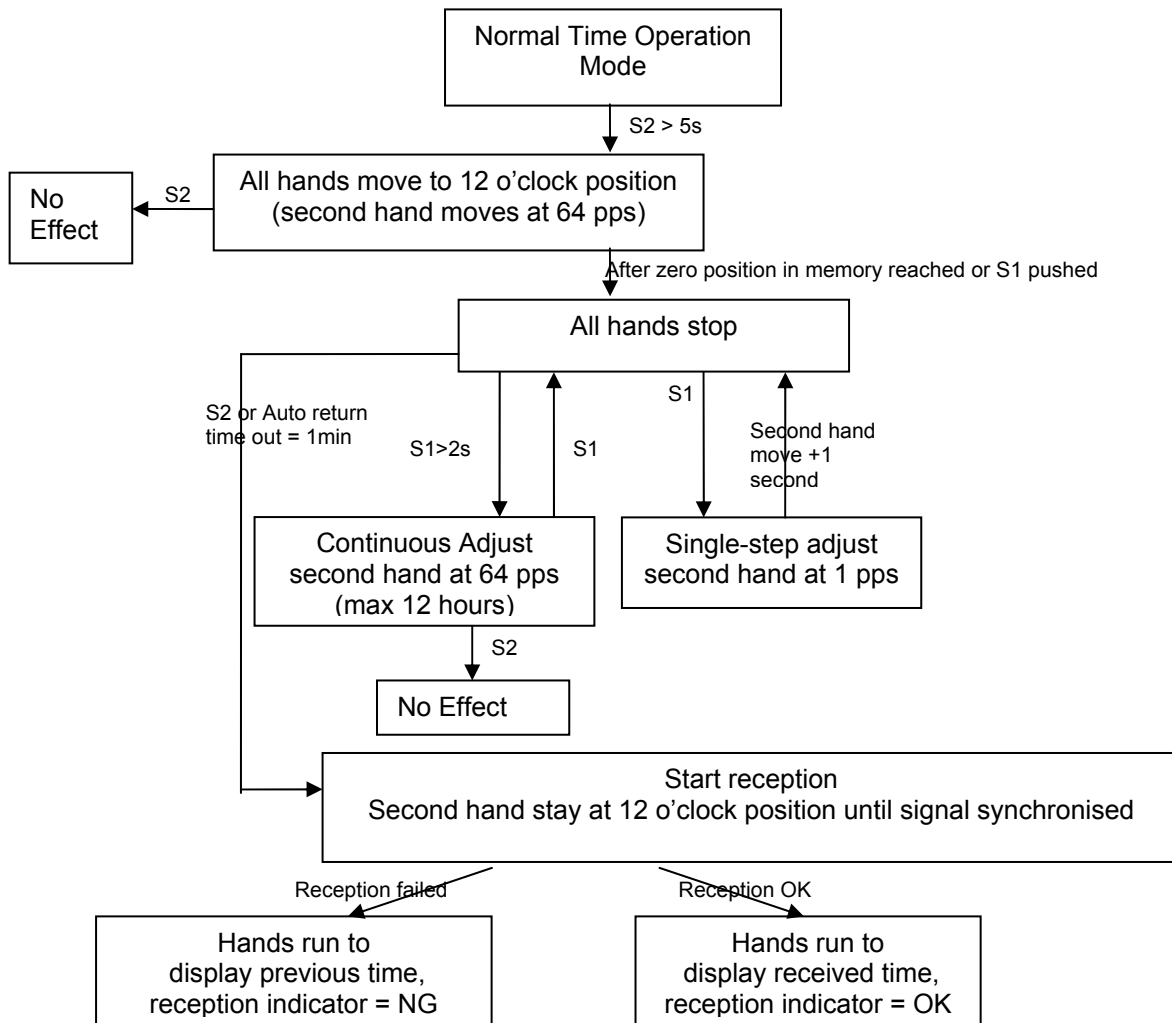

Automatically a receiving mode is started after the calibration mode is quitted by auto-return time out from any stage of the zero-calibration mode if no button is pressed for ≥ 1 minute. After zero calibration, reception will synchronize minutes, seconds, and hours.

4.3. Reception result indication

Reception OK =	Display RC icon :
Reception NG =	No RC icon displayed
No indication =	No RC icon displayed

Any new reception will update the status of the reception result as follows:



Possibilities for reception indication:

Cases:	Result:
Auto reception OK – Auto reception NG -	NG
Auto reception OK – Manual reception NG -	NG
Auto reception NG – Auto reception OK -	OK
Auto reception NG – Manual reception OK -	OK
Manual reception OK – Auto reception OK -	OK
Manual reception OK – Auto reception NG -	NG
Manual reception NG – Auto reception OK -	OK
Manual reception NG – Auto reception NG -	NG

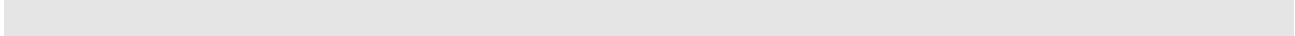
After exit time setting mode, reception indicator will show NG



4.4. RC Reception

- During reception, RC icon  will flash at 1 Hz and signal quality indicator  will appear (when available)
- if a signal is received the watch will be set to the new received time
- if no signal is received after time out, the watch will continue running as old time and no RC icon and no waves will be displayed.
- LCD will turn off RC icon and waves once reception is manually terminated.
- LCD will turn on RC icon and waves once reception is succeeded .
- Minute and hour hand (and second hand if any) will continue to move during reception.
- During reception, the signal quality will be displayed on the LCD.

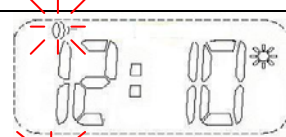
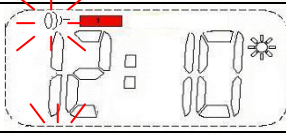
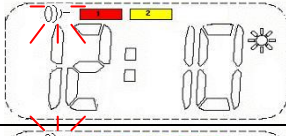
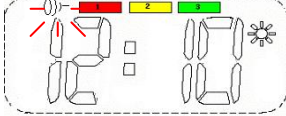
No waves		no signal available
1 wave		weak signal available
2 waves		good signal available, some interference
3 waves		best signal available

Reception sequence for JJY40 / JJY60 for first time reception is as diagram on right.

Next dual reception (automatic or manual) starts from last successfully selected transmitter. If reception failed, next reception sequence will be reversed.

Reception sequence for MSF/DCF is the same. First signal search depends on time zone selection and previous reception result.

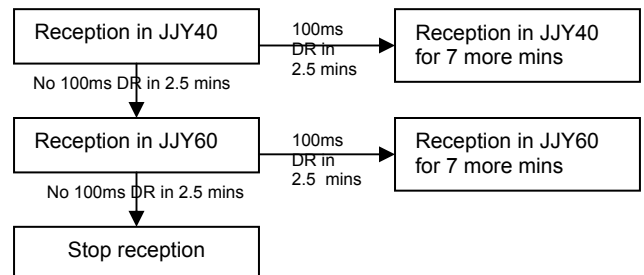

4.4.1 Manual Reception

- Manual reception can be started by pushing S1 > 2s.
- Manual can also be cancelled by pushing S1 >2s during reception.
- If any reception is cancelled, reception result will be NG.
- Signal to receive during manual reception depends on time zone set. For dual band time zones, this also depends on previous successful reception.

4.4.2 Automatic receiving mode

The signal will be checked every night starting at a defined time (see table below) automatically. If the reception was not successful, the signal will be checked again at minute 00 of the next full hour up to 2 more times again. After the 3rd failed reception, the watch will look again for signal in the next reception trial at the coming 3 am. Consecutive auto receptions are cancelled if the reception succeeded.

AUTO RECEPTION START TIME

Time Zone	Auto reception start time at x o'clock A.M. local time
UTC +0h	3, 4, 5
UTC +1h	3, 4, 5
UTC +2h	3, 4, 5
UTC +3h	3, 4, 5
UTC +4h to UTC +7h	No auto reception
UTC + 8	2, 3, 4
UTC + 9	2, 3, 4
UTC +10h to UTC + 12h	No auto reception
UTC -12h to UTC -10h	No auto reception
UTC -9h to UTC -5h	2, 3, 4
UTC -4h to UTC -1h	No auto reception

With press of S1 button > 2s, auto reception can be cancelled and the watch will display the pre-adjusted time.

4.5 Manual time setting

Items that can be set by the manual time setting mode includes:

Time Zone	: 24 hour time zone from UTC+12h to UTC -12h
DST control	: auto (from RCC signal), always on, always off
Hour	: 0 to 23
Minute	: 1 to 59
Year	: 01 to 98
month	: 1 to 12
date	: 1 to 31 (28, 29 or 30 for some months)

During time setting mode, the second hand will stop until exit setting mode or auto return time out after 1 minute of no action in setting mode, then second hand will fast move to catch up time. Within setting mode, press S1 to make changes or increment, press S2 to switch to next item and confirm present setting.

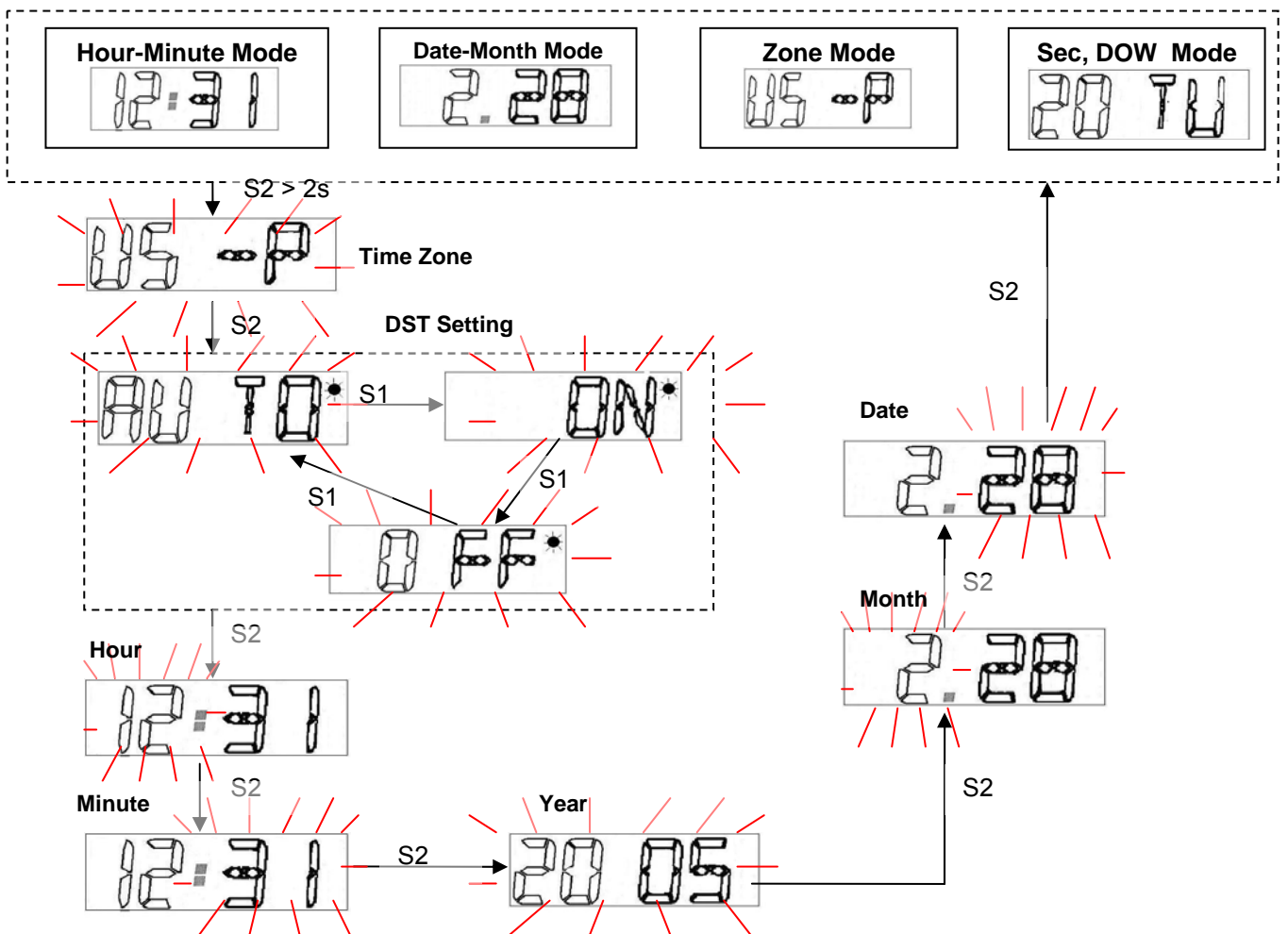

4.5.1 DST setting

Default DST setting depends on the adjusted time zone. If time zone is changed, the DST setting will also change according to the table in the next section. Within a certain time zone, the user can also change the DST setting as below, once changed, the DST setting will be set according to the user's change until time zone is being modified again.

For auto reception available areas:

DST ON (DST is forced on)
AUTO (DST according to RC signal's DST bits)
DST OFF (DST is forced off)

When DST is set to ON / OFF:

- if signal synchronised is DCF / MSF / JJY40 / JJY60, the watch will detect the signal DST status and change DST display according to signal. At this time, the DST setting will also be reverted to AUTO.
- if signal synchronised is WWVB, the watch will NOT detect the signal DST status and time and DST display will not change until time setting (including date, time zone, DST setting) is altered or if another signal is received.

For non-reception areas (refer to section 4.5.2):

Default setting of DST is off, but user can change this setting as follows:

DST ON (DST is enabled permanently until time zone change or user change of DST setting)
DST OFF (DST is disabled permanently until time zone change or user change of DST setting)

- The DST icon shows whether DST is active at the moment.
- Whether DST control is forced off, forced on or auto is shown in setting mode.

4.5.2 Time Zone setting

Time Zone	Symbol on LCD display	Default DST setting	Radio Control reception Signal				
			P12 = H	P12 = L P11 = L P10 = L	P12 = L P11 = L P10 = H	P12 = L P11 = H P10 = L	P12 = L P11 = H P10 = H
UTC -12h	- 12H	OFF	OFF	OFF	OFF	OFF	OFF
UTC-11h	- 11H	OFF	OFF	OFF	OFF	OFF	OFF
UTC -10h	- 10H	OFF	OFF	OFF	OFF	OFF	OFF
UTC -9h	- 09H	AUTO	WWVB	OFF	WWVB	OFF	OFF
UTC - 8h	US-P	AUTO	WWVB	OFF	WWVB	OFF	OFF
UTC -7h	US-M	AUTO	WWVB	OFF	WWVB	OFF	OFF
UTC -6h	US-C	AUTO	WWVB	OFF	WWVB	OFF	OFF
UTC -5h	US-E	AUTO	WWVB	OFF	WWVB	OFF	OFF
-UTC-4h	- 04H	OFF	OFF	OFF	OFF	OFF	OFF
UTC -3h	- 03H	OFF	OFF	OFF	OFF	OFF	OFF
UTC -2h	- 02H	OFF	OFF	OFF	OFF	OFF	OFF
UTC -1h	- 01H	OFF	OFF	OFF	OFF	OFF	OFF
UTC	UK	AUTO	MSF->DCF	OFF	OFF	MSF->DCF	MSF->DCF
UTC +1h	EU	AUTO	DCF->MSF	OFF	OFF	DCF->MSF	DCF->MSF
UTC +2h	2H	AUTO	DCF	OFF	OFF	OFF	DCF
UTC +3h	3H	OFF	OFF	OFF	OFF	OFF	OFF
UTC +4h	4H	OFF	OFF	OFF	OFF	OFF	OFF
UTC +5h	5H	OFF	OFF	OFF	OFF	OFF	OFF
UTC +6h	6H	OFF	OFF	OFF	OFF	OFF	OFF
UTC +7h	7H	OFF	OFF	OFF	OFF	OFF	OFF
UTC +8h	CN	OFF	J6	OFF	OFF	OFF	OFF
UTC +9h	JP	OFF	J4 -> J6	J4 -> J6	OFF	OFF	OFF
UTC +10h	10H	OFF	OFF	OFF	OFF	OFF	OFF
UTC +11h	11H	OFF	OFF	OFF	OFF	OFF	OFF
UTC +12h	12H	OFF	OFF	OFF	OFF	OFF	OFF

After a different time zone is set, the default DST setting and signal to be received may change accordingly.

4.6 Hands adjustment

There are 4 cases that the 3-hands of the watch will fast move to adjust:

- 1) After successful reception of signal and time is different to existing time
- 2) After change of time zone
- 3) After change of DST setting
- 4) During zero calibration

During fast adjustment of watch hands, manual reception function will be disabled. Settings adjustment is still possible, once in setting mode, hands will stop until exit setting mode, then it will resume fast run to set time. If auto reception time is reached during hands adjustment, the reception will be postponed until hands finished adjustment and restarted at the next second 00 after adjustment.

The worst case for hands adjustment is when hands have to move 12 hours. Fast movement of second hand is at 64 Hz. Therefore worst case duration for hands adjustment is around 11 minutes.

4.7 Low battery indication

If battery voltage level falls below 2.3V, the low batt icon  will be turned on, until the battery is being replaced.

4.8 Antenna Tuning Mode

After reset, LCD will show full screen display for 3 seconds:

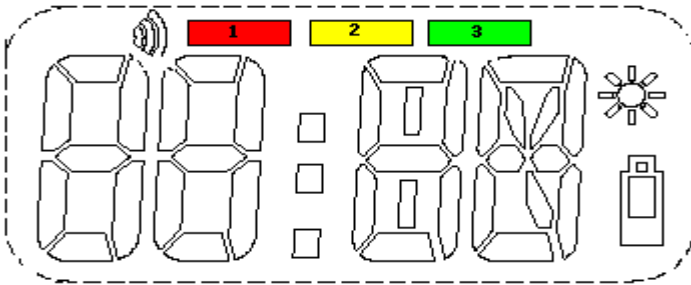

During full screen display, if S2 is pushed once, watch will enter antenna tuning mode, all hands will not move and user can select between different reception signals to antenna frequency:

- 1) JP 40 : JJY40
- 2) JP 60 : JJY60
- 3) US : WWVB
- 4) UK : MSF
- 5) EU : DCF

The corresponding signal will appear and flash on the LCD during selection, and by pressing S1, signals can be scrolled through. By pressing S2, the flashing signal will be selected. Upon selection, the signal abbreviation will stop flashing and from hereon, the CME8000 will be set to receive the chosen the signal and analog signal output will appear on the TEST pin if 100nF is attached to the pin connected to GND.

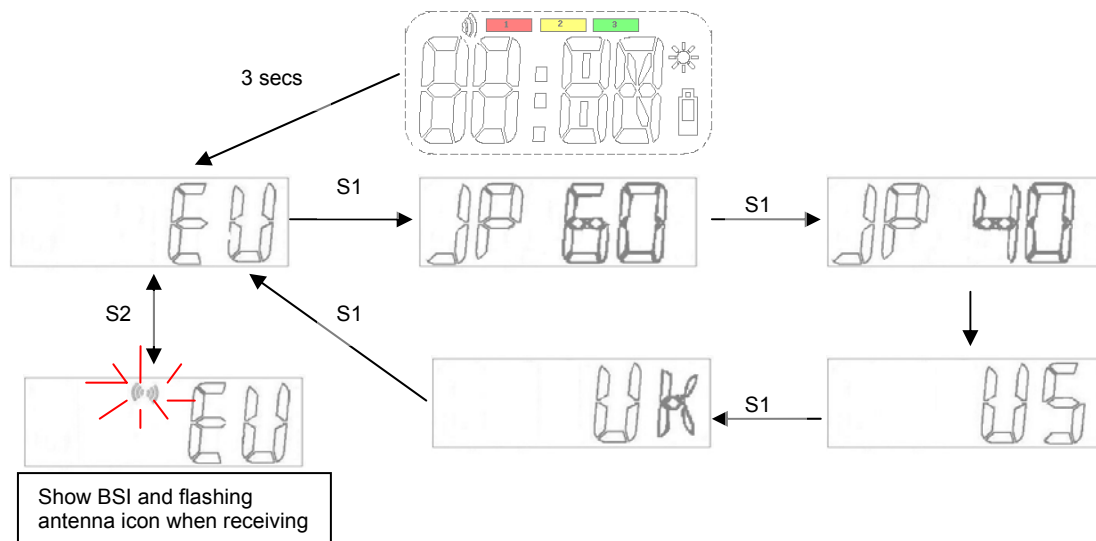

Disclaimer of Warranty

Information furnished is believed to be accurate and reliable. However C-MAX assumes no responsibility, neither for the consequences of use of such information nor for any infringement of patents or other rights of third parties, which may result from its use. Specifications mentioned in this publication are subject to change without notice. This publication supersedes and replaces all information previously supplied. C-MAX products are not authorized for use as critical components in life support devices without express written approval of C-MAX.

Note

It is not given warranty that the declared circuits, devices, facilities, components, assembly groups or treatments included herein are free from legal claims of third parties. The declared data are serving only to description of product. They are not guaranteed properties as defined by law. The examples are given without obligation and cannot give rise to any liability.

Reprinting this data sheet - or parts of it - is only allowed with a license of the publisher.

C-MAX reserves the right to make changes on this specification without notice at any time.

C-MAX Asia Ltd

Unit 125, 1/F.,
Liven House,
61-63 King Yip Street,
Kwun Tong, Kowloon, HK SAR
Tel.: +852-2798-5182
Fax: +852-2798-5379
e-mail: inquiry@c-max.com.hk

C-MAX Technology Ltd (Shenzhen)

Room 31C, Block A,
World Finance Centre,
No. 4003 Shennan East Road,
Luohu, Shenzhen, PR China
Tel: +86-755-25181858
Fax: +86-755-25181859